

National curriculum tests

Key stage 1

Mathematics

Paper 2: reasoning

First name	
Middle name	
Last name	

SAMPLE BOOKLET

Published July 2015

This sample test indicates how the national curriculum will be assessed from 2016. Further information is available on GOV.UK at www.gov.uk/sta.

Total marks	
-------------	--



Amy



Abdul

Sam

Ben

Sita

Practice question

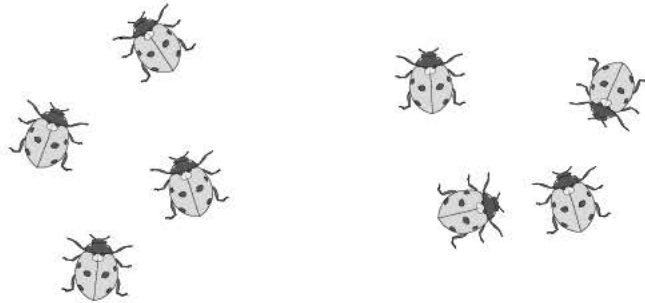

ladybirds

1



2



3



2 cm

2 kg

2 °C

2 l



4

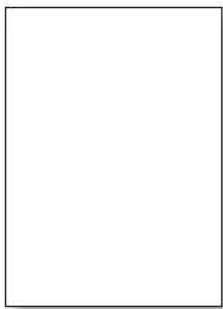

5

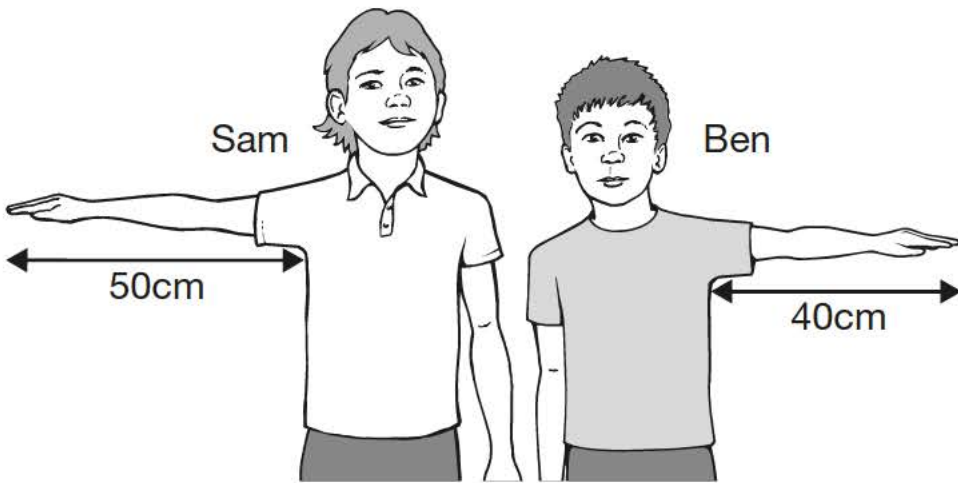

6

Look at the shapes.

Tick (✓) the hexagon.

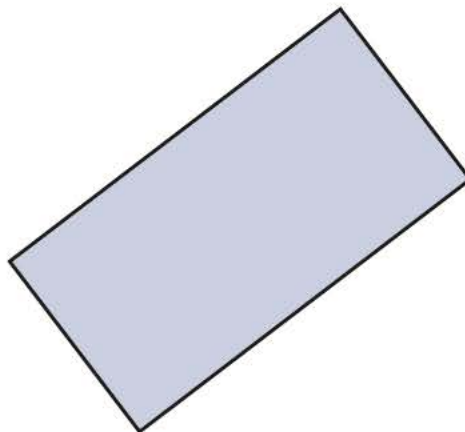
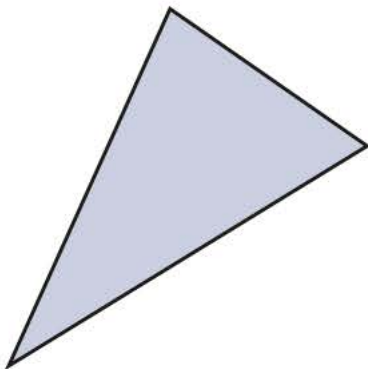
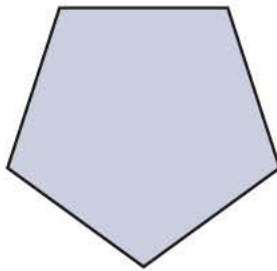
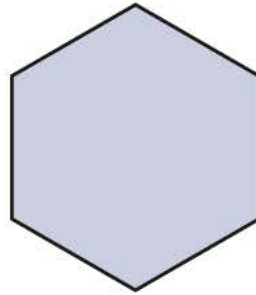
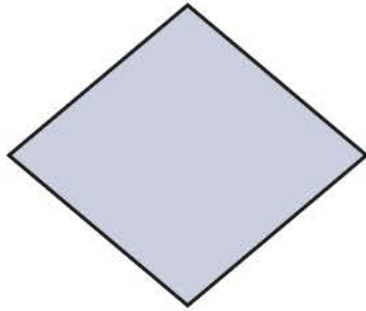

7

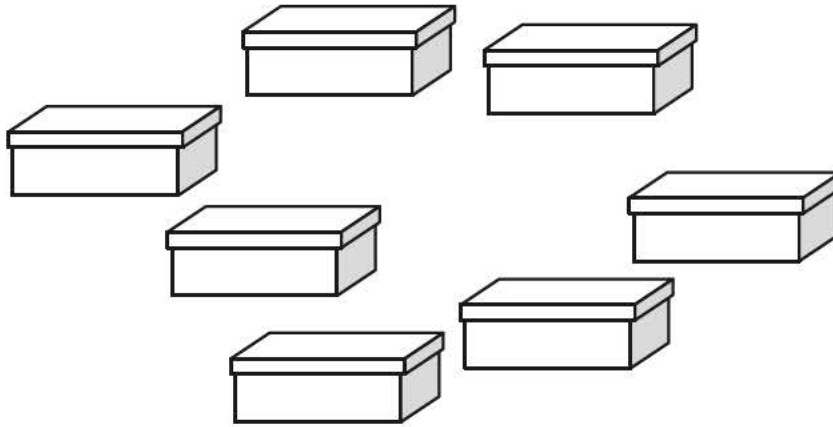

Sita puts **2** shoes in each of these boxes.

How many shoes are there altogether?

shoes

8

Complete the table.

words	digits
thirty-eight	38
	40
ninety-four	

9

Here are two shape patterns.

Draw a shape in each empty box to make the patterns correct.

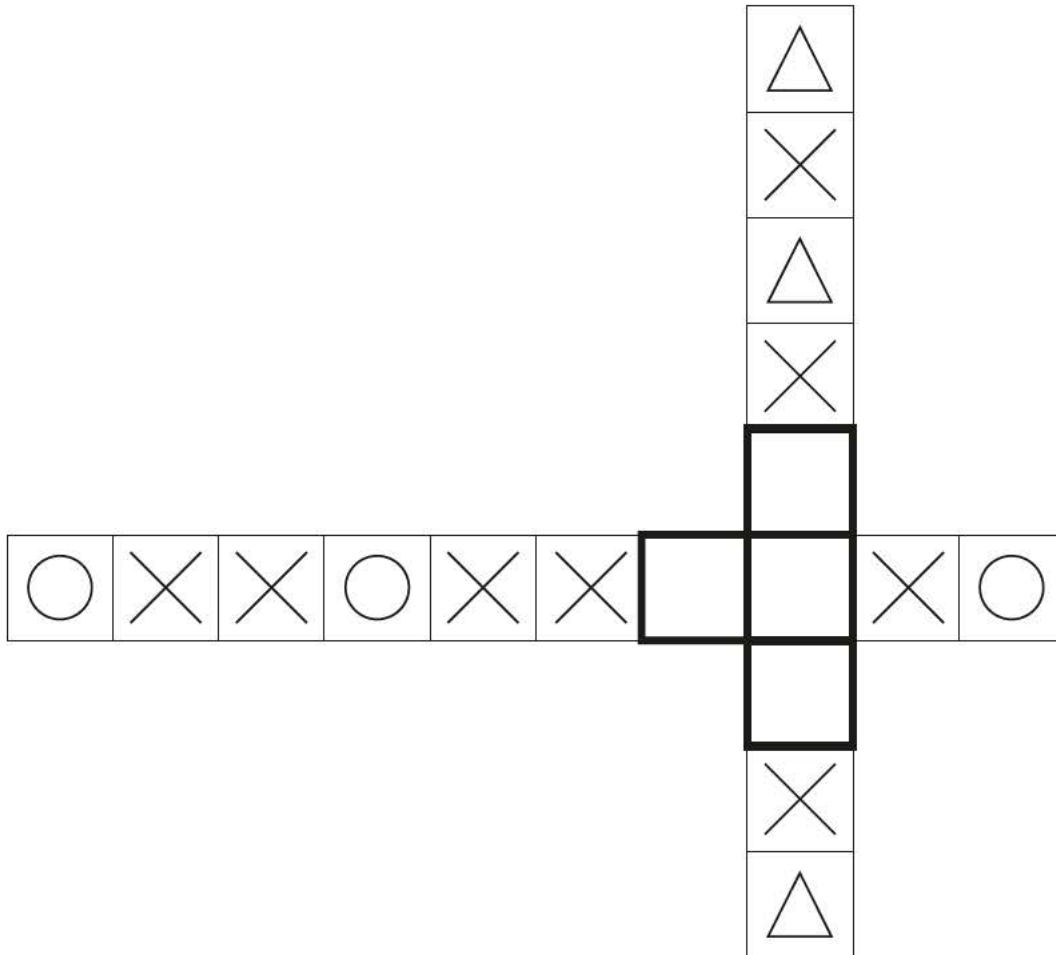

10

Write the **two** missing numbers in this pattern.

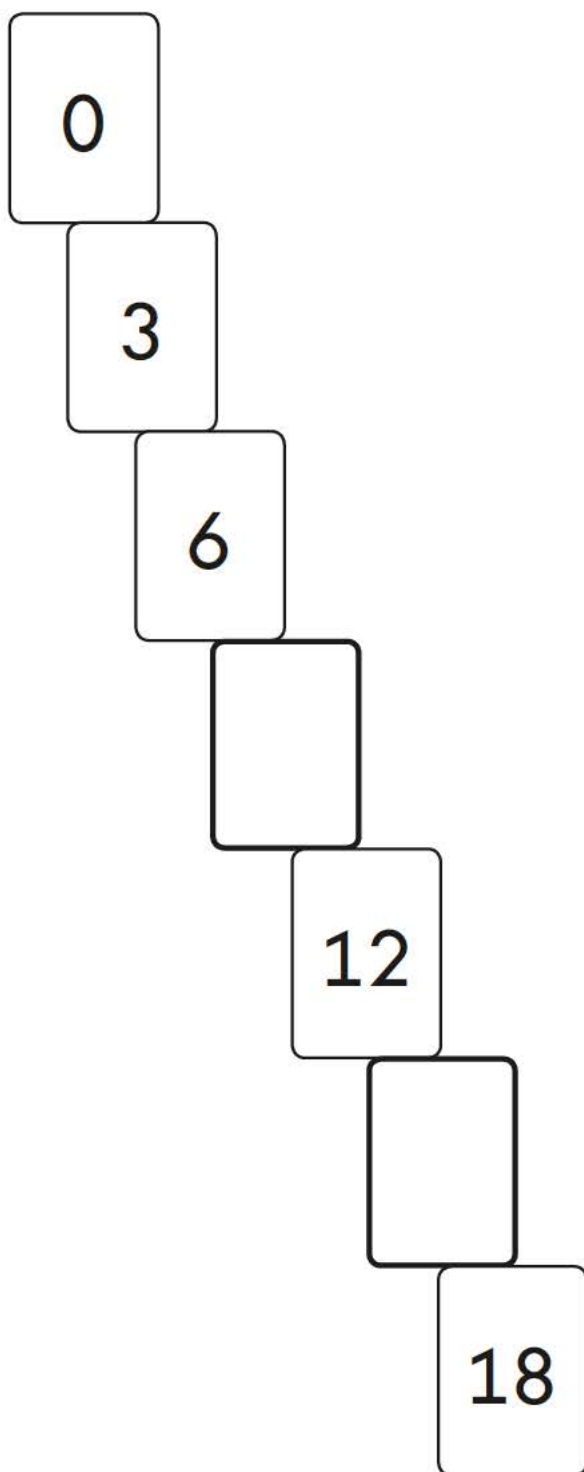

- 11 Use a ruler to measure the length of the toy car.

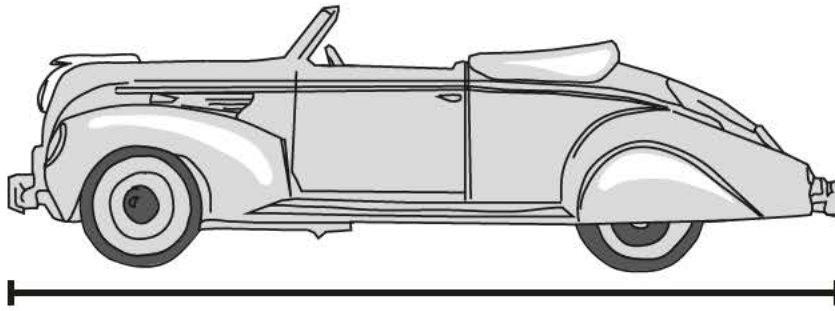

- 12 Two of the numbers are in the **wrong** bag.

Draw a cross (X) on each of them.

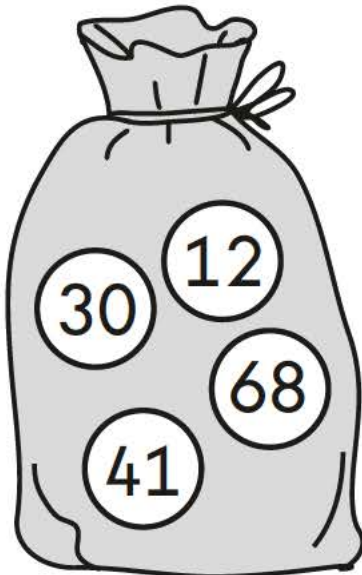

even numbers

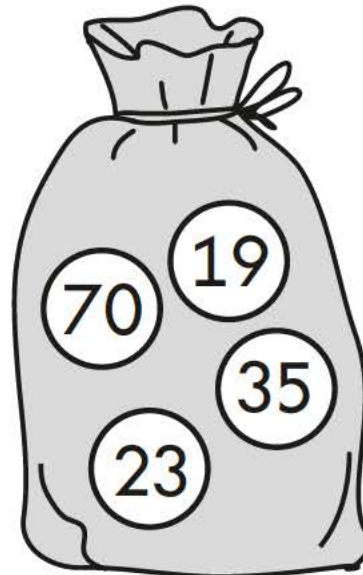

odd numbers

13 Ben has 13 crayons.

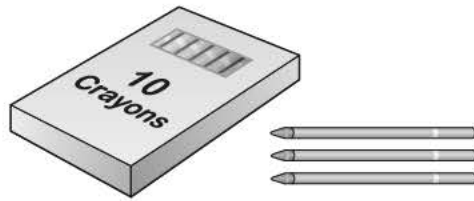

Here are Abdul's crayons.

How many crayons does Abdul have?

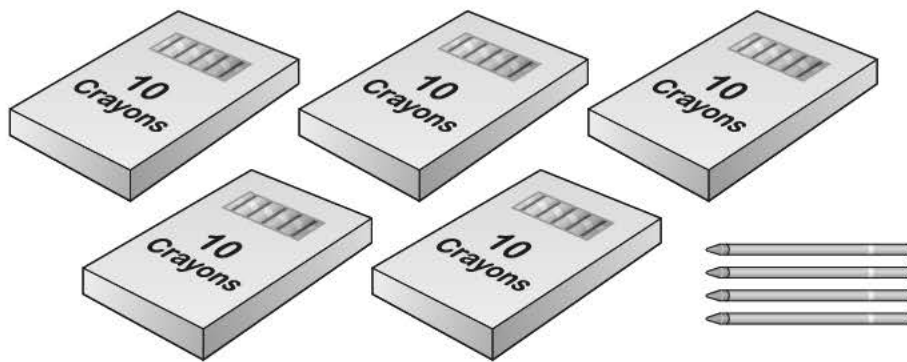

crayons



M004175

14

One shape is in the **wrong** place on the sorting grid.

Draw a cross (X) on it.

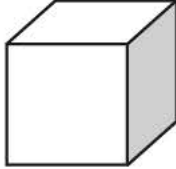
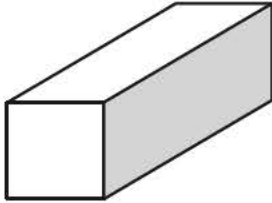
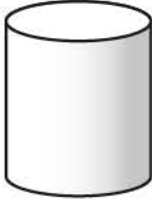
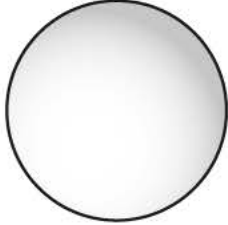
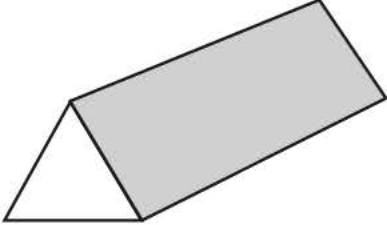
Shapes with a square face	Shapes without a square face
  	 

15 A shop sells these sweets.

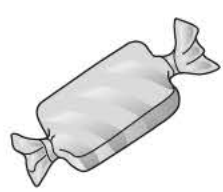

2p

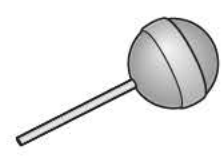

5p

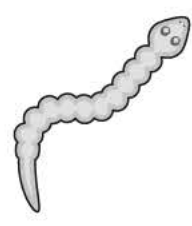

10p

Abdul spends exactly **20p** on sweets.

Tick (✓) the bag of sweets he buys.

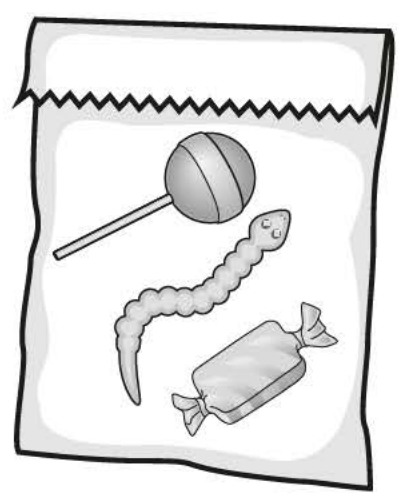
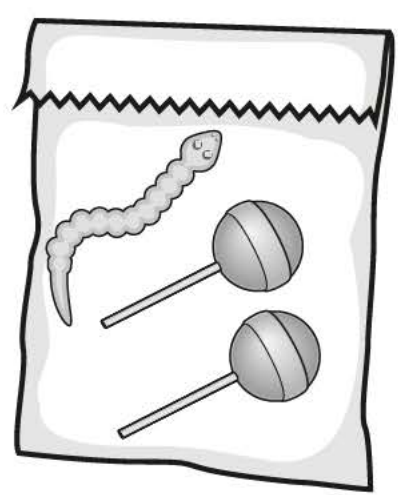

16

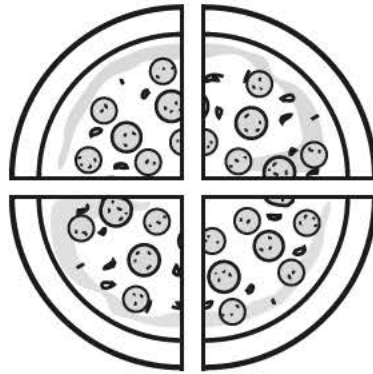

Sita cuts a pizza into four equal slices.

She eats one slice.

What fraction of the pizza does she eat?

17 Sam is collecting cards.

He wants to collect **100** cards altogether.

Last week he collected **50** cards.

This week he collects **30** cards.



How many **more** cards does he need?

cards

18

This diagram shows the number of animals at a farm.

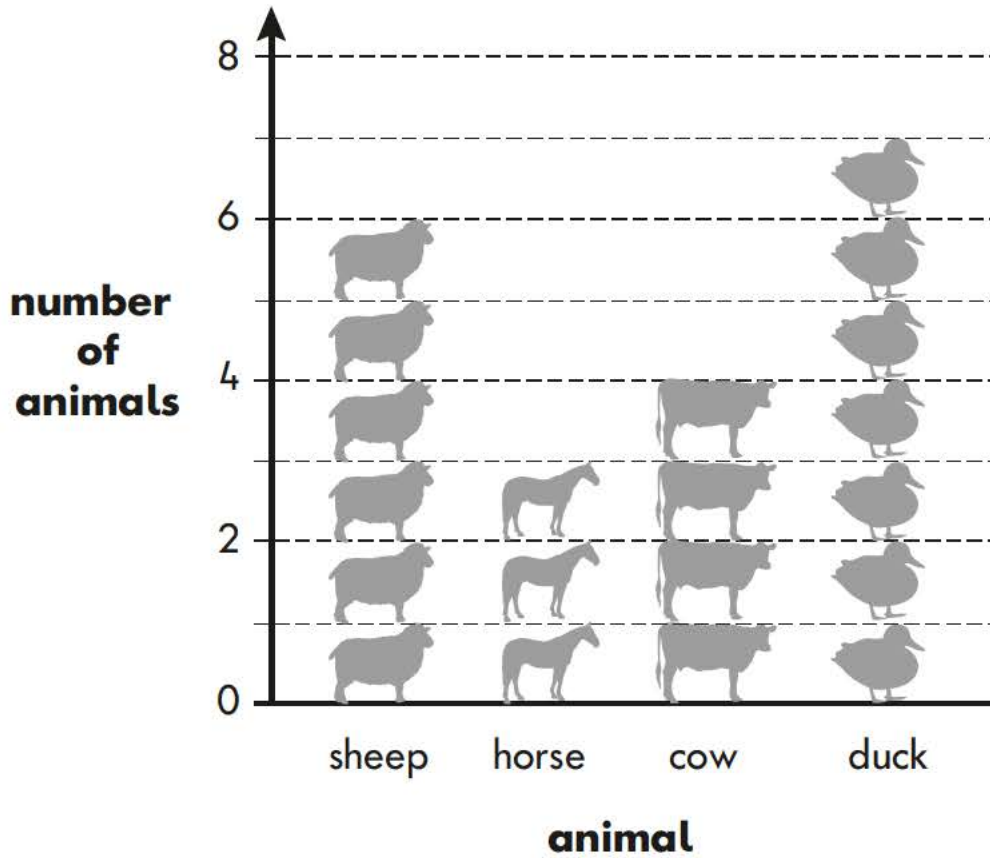

(a) How many sheep and cows are there altogether?

(b) There are more ducks than horses. How many more?

19

Amy buys an ice-cream for 90p.



(a) Tick (✓) **three** coins to show how Amy can make **90p**.



(b) Tick (✓) **four** coins to show another way to make **90p**.



20 Look at the number line.

Write the correct number in the box.

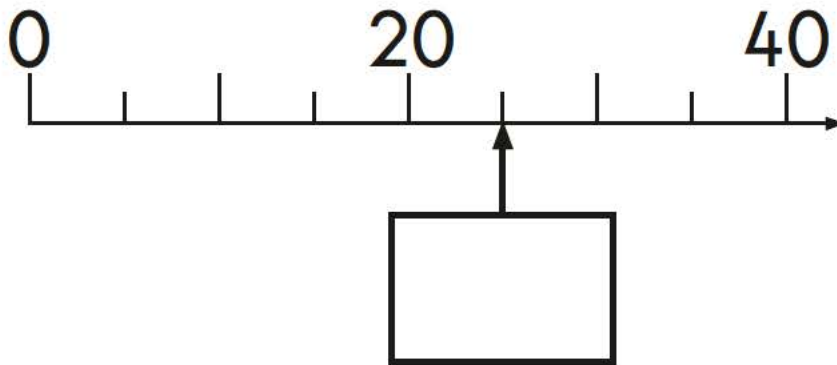

21 Draw a line of symmetry on each of these shapes.

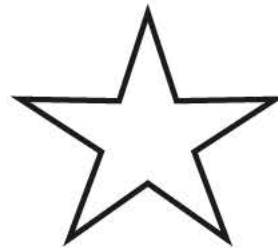

22 Amy plants **4** rows of carrots.

There are **3** carrots in each row.

A rabbit eats **2** of the carrots.

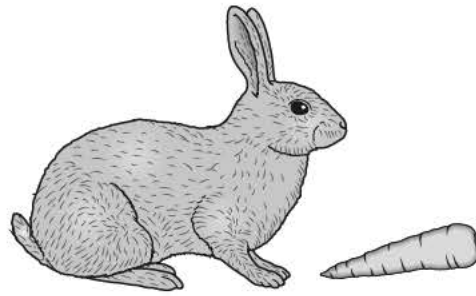

How many carrots are left?

Show
your
working

carrots

2 marks

23

Amy writes an answer to the calculation below.

$$57 - 31 = \boxed{26}$$

Now write an addition **to check Amy's answer**.

$$\boxed{} + \boxed{} = \boxed{}$$

24

Write a digit in each box to make the sum correct.

$$\begin{array}{|c|c|} \hline 7 & \\ \hline \end{array} + \boxed{} = \begin{array}{|c|c|} \hline 8 & 3 \\ \hline \end{array}$$

25

Draw the minute hand on the clock to show **twenty-five past eight**.

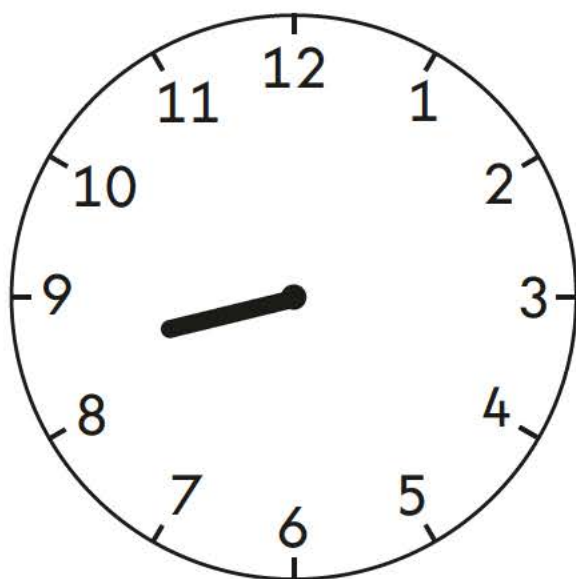

26

Amy makes **20** cakes.

She shares the cakes between **5** plates.

Tick the calculation that shows how many cakes are on each plate.



Tick **one**.

$20 + 5 = 25$

$20 - 5 = 15$

$20 \div 5 = 4$

$20 \times 5 = 100$



27

Sita has **50** raisins.

She gives **23** to Ben.

She gives **15** to Amy.



How many raisins does Sita have left?

Show
your
working

raisins



2 marks

Abdul goes to the zoo.

He finds out the mass of some animals.



Cheetah
58 kg

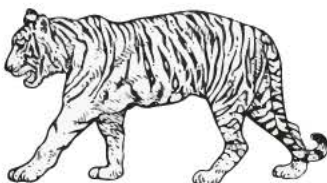

Tiger
94 kg

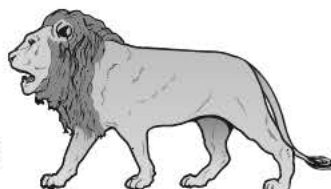

Lion
94 kg

Compare the mass of the animals.

Write $<$ or $>$ or $=$ in each box.

Cheetah's mass

Tiger's mass

Tiger's mass

Lion's mass

29

Do these calculations have the same answer?

Write **yes** or **no** next to each box.

One is done for you.

$$8 + 2 \quad \text{and} \quad 2 + 8$$

yes or **no**?

yes

$$8 \times 2 \quad \text{and} \quad 2 \times 8$$

$$8 - 2 \quad \text{and} \quad 2 - 8$$

$$8 \div 2 \quad \text{and} \quad 2 \div 8$$



30 Look at these fractions.

$$\frac{1}{2}$$

$$\frac{1}{3}$$

$$\frac{2}{4}$$

$$\frac{3}{4}$$

Circle the **two** fractions that are **equal**.



31 Complete the number sentence below.

$$3 \times 8 = 2 \times \square$$



END OF TEST

[BLANK PAGE]

Please do not write on this page.

[BLANK PAGE]

Please do not write on this page.



Sample key stage 1 mathematics test Paper 2: reasoning
Electronic PDF version product code: STA/15/7315/e ISBN: 978-1-78315-733-4

For more copies

Additional printed copies of this booklet are not available. It can be downloaded from www.gov.uk/government/publications.

© Crown copyright and Crown information 2015

Re-use of Crown copyright and Crown information in test materials

Subject to the exceptions listed below, the test materials on this website are Crown copyright or Crown information and you may re-use them (not including logos) free of charge in any format or medium in accordance with the terms of the Open Government Licence v3.0 which can be found on the National Archives website and accessed via the following link: www.nationalarchives.gov.uk/doc/open-government-licence. When you use this information under the Open Government Licence v3.0, you should include the following attribution: 'Contains public sector information licensed under the Open Government Licence v3.0' and where possible provide a link to the licence.



Exceptions – third-party copyright content in test materials

You must obtain permission from the relevant copyright owners, as listed in the '2016 sample tests copyright report', for re-use of any third-party copyright content which we have identified in the test materials, as listed below. Alternatively you should remove the unlicensed third-party copyright content and/or replace it with appropriately licensed material.

Third-party content

These materials contain no third-party copyright content.

If you have any queries regarding these test materials contact the national curriculum assessments helpline on 0300 303 3013 or email assessments@education.gov.uk.